

# HU2

# Spa Owner's Manual

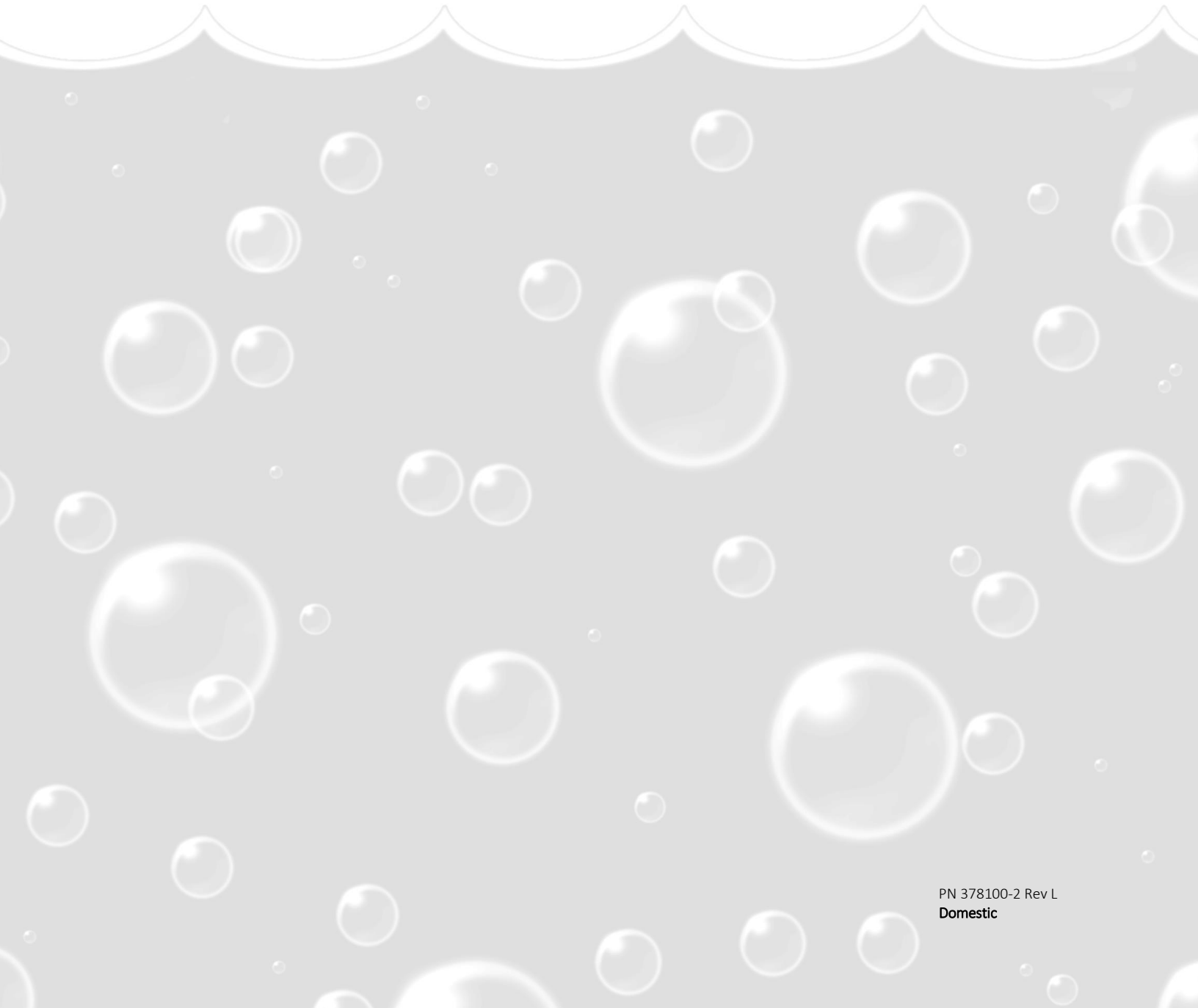

# OWNER'S INFORMATION

## DEALER

Company \_\_\_\_\_  
Address \_\_\_\_\_  
Phone \_\_\_\_\_  
E-mail \_\_\_\_\_

## INSTALLER

Company \_\_\_\_\_  
Address \_\_\_\_\_  
Phone \_\_\_\_\_

## SPA

Model (see below) \_\_\_\_\_  
Serial Number (see below) \_\_\_\_\_  
Color \_\_\_\_\_  
Date of Delivery \_\_\_\_\_

For the model and serial numbers, locate the white plate to the right or left of the access door, near the floor.

	<b>Roto Ops LLC</b> Lake Mary, FL CONFORMS TO UL STD 1563 CERTIFIED TO CAN/CSA STD C22.2 NO 218.1-M89 ESA # 9000081	<b>RATINGS:</b>
	<b>Model No.:</b> _____ <b>Mfg Date:</b> _____ FOR INDOOR/OUTDOOR USE	Volts: _____ Amps: _____ CirBkr: _____ Hz: _____ SN: _____

## TABLE OF CONTENTS

IMPORTANT SAFETY INSTRUCTIONS.....	4-5
SELECT ELECTRICAL MODE AND A LOCATION.....	6
SPA COVER INSTALLATION.....	7
FILLING YOUR SPA.....	8
DRAINING YOUR SPA.....	8
SYSTEM OPERATION.....	9-10
DISPLAY MESSAGES.....	11
FOR THE ELECTRICIAN, CONVERSION FROM 120V TO 240V.....	12-14
AIR INJECTION VENTURI ADJUSTMENT.....	15
SURFACE SKIM FILTER .....	15
REMOVING AND CLEANING THE FILTER CARTRIDGE .....	15
WATER CHEMISTRY.....	16-17
REPLACING THE LED LIGHT.....	18
FREEZE PROTECTION.....	19
CLEANING YOU SPA.....	19
CARE FOR THE VINYL HARD COVER.....	19
EVERY DAY SOIL.....	19
MOST FREQUENTLY ASKED QUESTIONS.....	20
PURGING THE PUMP.....	21
TROUBLESHOOTING GUIDE.....	22
GLOSSARY OF TERMS.....	23

# Important Safety Instructions

When installing and using this electrical equipment, basic safety precautions should always be followed, including the following:

## READ AND FOLLOW ALL INSTRUCTIONS

1. **WARNING:** To reduce the risk of injury, do not permit children to use this product unless they are closely supervised at all times.
2. **WARNING:** A wire connector is provided on this unit to connect a minimum 6 AWG (4.11 mm) solid copper conductor between this unit and any metal equipment, metal enclosures of electrical equipment, metal water pipe, or conduit within 5 feet (1.5m) of the unit.
3. **DANGER RISK OF INJURY:** (For cord and plug connected units):
  - a. Replace damaged cord immediately
  - b. Do not bury cord
  - c. Connect to a grounded, grounding type receptacle only.
4. **WARNING:** (For units with a Ground Fault Circuit Interrupter (GFCI): This product is provided with a Ground Fault Circuit Interrupter GFCI on the end of the spa's power cord. This GFCI must be tested before each use. With the product operating depress the "test" button on the GFCI the spa should not operate. Depress the "reset" button on the GFCI. The product should now operate normally. If the spa fails to operate in this manner, there is a ground current flowing indicating a possible electric shock. Disconnect the power until the fault has been identified and corrected by a certified licensed electrician.
5. **WARNING:** (For permanently installed units):

The electrical supply for this product must include a suitably rated switch or circuit breaker to open all ungrounded supply conductors to comply with Section 442-20 of the National Electric Code. ANSI / NFPA 70-1987. In addition, all 230 volt installations must be protected by a 230 volt Ground Fault Circuit Interrupter GFCI. Any GFCI circuit breaker used in the house panel must read current returning through the neutral conductor. 230 volt 2 conductor GFCI circuit breakers will not operate correctly for your application.
6. **DANGER RISK OF ACCIDENTAL DROWNING:** Extreme caution must be exercised to prevent unauthorized access by children. To avoid accidents, ensure that they cannot use this spa unless they are supervised at all times. For additional protection, use a cover which is classified by the Underwriters Laboratories Meeting ASTM F1346-91 requirements. The cover supplied by the manufacturer meets these requirements.
7. **DANGER RISK OF INJURY:** If your spa is equipped with suction fittings, the suction fittings in this spa are sized to match the specific water flow created by the pump. Should the need arise to replace the suction fittings or the pump, be sure that the flow rates are compatible. Never operate spa if suction fittings are broken or missing. Never replace a suction fitting with one less than the flow rate marked on the original suction fitting.
8. **DANGER RISK OF ELECTRIC SHOCK:** Install at least 5 feet (1.5m) from all metal surfaces. As an alternative, a spa may be installed within 5 feet (1.5m) of metal surfaces if each metal surface is permanently connected by a minimum 6 AWG (4.11 mm) solid copper conductor to the wire connector on the terminal box that is provided for this purpose.
9. **DANGER RISK OF ELECTRIC SHOCK:** Do not permit any electric appliance, such as light, telephone, radio, or television, within 5 feet (1.5m) of a spa.
10. **WARNING TO REDUCE THE RISK OF INJURY:**
  - a. The water in a spa should never exceed 104°F (40°C). Water temperatures between 100°F (38°C) and 104°F (40°C) are considered safe for a healthy adult. Lower water temperatures are recommended for your children and when spa use exceeds 10 minutes.
  - b. Since excessive water temperatures have high potential for fetal damage during the early months of pregnancy, pregnant or possibly pregnant women should limit spa water temperatures to 100°F (38°C).
  - c. Before entering spa, the user should measure the water temperature with an accurate thermometer since the tolerances of water temperature-regulating devices vary.
  - d. The use of alcohol, drugs, or medication before or during spa use may lead to unconsciousness with the possibility of drowning.
  - e. Persons suffering from obesity or with a medical history of heart disease, low or high blood pressure, circulatory system problems, or diabetes should consult a physician before using a spa.
  - f. Persons using medication should consult a physician before using a spa since some medication may induce drowsiness while other medication may affect heart rate, blood pressure, and circulation.

(Safety instructions continued on next page)

11. **WARNING:**
  - a. People with infectious diseases should not use a spa or hot tub.
  - b. To avoid injury, exercise care when entering or exiting a spa or hot tub.
  - c. Do not use a spa or hot tub immediately following strenuous exercise.
  - d. Prolonged immersion in a spa or hot tub may be injurious to your health.

12. **Caution:** Maintain water chemistry in accordance to manufacturer's instructions.

Your spa can be a source of great pleasure. It offers healthful stimulating recreation and is a delightful fun center for you, your family and friends. However, it contains large quantities of water and is deep enough to present inherent dangers to life and health unless the following safety rules are strictly observed.

13. **Never permit the spa to be used unless it is attended by at least one person other than the bather.**

Someone should be present to lend assistance if the bather should be in trouble due to injuries, cramps, or drowning, especially in case of children.

14. **Always use care in and around your spa.**

The spa has many rigid, unyielding parts and many areas that become wet and slippery; these are all potentially dangerous when rough play is permitted or if care is not used, particularly when entering or leaving the spa.

15. **Keep the water sanitary and healthful at all times.**

Your filter system will remove suspended particles from the water. Regular application of spa chemicals in proper quantities will destroy harmful bacteria and prevent formation of algae. Your surface skimmer will remove insects, leaves, and other debris from the water surface. Unsanitary water is a serious health hazard.

16. **The water in your spa must NOT be warmer than 100°- 104° F (38°-40°C).**

Always keep an accurate thermometer in the water because your spa's thermostat may be in error. Use a high quality, shatterproof thermometer with increments of one degree or less.

The National Spa and Pool Institute consider a temperature of 100°F (38°C) safe and comfortable for a healthy adult.

Most healthy adults can enjoy this water temperature for as long as desired, although it may raise the body temperature to the water temperature and eventually become uncomfortable (like a fever). At higher water temperatures the soaking time should be shorter; never soak for more than 20 minutes when the water temperature is 102°F (39°C) or higher. If you are planning a long rest in the spa, lower the water temperature closer to normal body temperature, about 99°F (37.2°C). Some people find even lower water temperatures relaxing and pleasing. Try different water temperatures in the 98°-102°F (36.6°-39°C) range until you find what temperatures suit you best.

17. **Hot water can raise the body temperature high enough to cause heat stroke.**

This can be fatal even to healthy adults. If you have any questions about your own fitness or whether you should soak in the spa, check with your physician.

18. **Prolonged immersion in hot water may induce hyperthermia.**

Hyperthermia occurs when internal body temperature reaches a level several degrees above the normal body temperature of 98.6°F (36.6°C). The symptoms of hyperthermia include: (1) dizziness, (2) fainting, (3) drowsiness, (4) lethargy, (5) increases in the internal body temperature. The effects of hyperthermia include: (1) unawareness of impending hazard, (2) failure to perceive heat, (3) failure to recognize the need to exit spa, (4) physical inability to exit spa, (5) unconsciousness resulting in danger of drowning.

19. **WARNING: The use of alcohol, drugs, or medication can greatly increase the risk of fatal hyperthermia in hot tubs or spas.**

Despite the popular image of people in spas drinking wine or other alcoholic beverages, DO NOT use alcoholic beverages before or during spa use. Alcohol is a depressant which causes slowed reflexes and drowsiness, especially in conjunction with the relaxed soaking in hot water. This can lead to sleep or unconsciousness and possibly result in drowning. Using your spa with other people who are also drinking is not a preventative measure since they are likely to become similarly affected by the combinations of alcohol and hot water soaking.

Soaking in hot water causes changes in the circulatory system, such as enlargement of blood vessels near the skin.

Therefore, people with a medical history of heart disease, circulatory problems, diabetes, high or low blood pressure should check with their physician before using spas. Additionally, people taking medications causing drowsiness, such as tranquilizers, narcotics, antihistamines, or anticoagulants should not use spas without asking their physician.

20. **If equipped, broken or missing drain covers should be replaced immediately.**

Accidents can occur when long hair or a body part is trapped by suction from a drain or outlet whose cover is broken or removed. Children are particularly vulnerable, and they should be warned against danger.

21. **WARNING:** Do not use electrical appliances in or around your spa. Do not use glass or other breakable items in or around your spa. Do not remove spa cabinet panels and attempt to make repairs. Do not attempt electrical repairs. Retain a certified licensed electrician.

22. **This spa is for residential use only.** It is not intended for commercial use.

**SAVE THESE INSTRUCTIONS**

## Selecting electrical mode and a location

### Will you operate the spa on 120 or 240 volts?

Your spa comes ready to plug into a standard 120 volt / 15 amp outlet for power. However, it can be converted for a 240 volt hard-wired power supply installed by a licensed certified electrician. Please read the following to help with your decision.

**120 volts:** When connected with the 120 volt plug, the heater is 1000 watts and operates only in the low speed filtration mode. When the jet pump operates, the heater will turn off. This means the water will begin to cool while using the jet pump and the heat recovery time will take longer than it will if wired 240 volts. Many find this adequate due to their mild climate or shorter length of usage. Additionally, many prefer not to hire an electrician for the installation.

**240 volts:** When hard-wired to a 240 volt power supply, the heater is 4000 watts. It can operate on a 30 or 50 amp service.

**On a 30 amp service** the heater will not operate with the jet pump. However, the higher heater wattage will greatly increase the heat recovery time. The 30 amp circuit is often selected when there is limited available power as seen in some older homes.

**On a 50 amp service** the heater will operate with both high and low speed. This means the spa will heat while you operate the jet pump.

### If you have decided to operate your spa on 120 volts, will your electrical cord reach an outlet?

Locate your spa so that the GFCI plug and cord will reach a standard 120 volt / 15 amp outlet\*, but not closer than 5 feet (1.5m). Do not use an extension cord. To extend the power cord, with a Philips screw driver remove the access door shown in Fig 1A, locate the coiled GFCI cord, uncoil and extend the cord as shown in Fig 1A. Assure that the cord is routed through the notch at the lower center of the opening before reinstalling the access door. Do not connect to the outlet until the spa is filled with water (see page 8).

If you have decided to convert your spa to 240 volts, a certified licensed electrician is required for the electrical installation. In this case, you may want to consult with your electrician before final positioning of your spa. Have your electrician see pages 12-14 for conversion instructions.

### Is permitting required for construction, electrical, or barriers?

Most cities and counties require permits for exterior construction and electrical circuits. Some areas have codes requiring barriers such as fencing and/or self-closing gates on property to prevent unsupervised access to the property by children. Your local code enforcement department can provide information on which permits may be required and how to obtain them before delivery of your spa

### Is the support surface adequate to support the weight of the spa?

Provide a solid flat level load-bearing surface. The surface must provide a solid foundation with a minimum load bearing capacity of 125 pounds per square foot (610 kg per square meter). Concrete slabs and decks must be designed to support this weight.

**Warning!** Your spa is constructed of a very resilient and flexible polymeric material. It is designed to flex as much as 2 inches (5cm) without damage. However, overfilling the spa and/or installing on a non-level surface for extended periods of time can permanently distort the original shape of your spa, cause structural damage, effect the sealing of the cover and may void your warranty in this area.

### Is the support surface impervious to water and adequate to handle water overflow?

The surface must be suitable for a wet location and allow for adequate drainage for overflow water

### Are there considerations for limiting access by children?

Childproof Your Spa. Plan for limiting access by children. Take precautions such as self-closing, locking gates, access doors, fencing and other child barriers, as dictated by the site.

### Are there overhead electrical lines?

Do not locate your spa under overhead power lines or in near proximity to existing buried or exposed electrical circuits.

### Is there adequate room to access the service door, drain, filter and insulating cover removal?

If you are installing your spa near a wall or with any type of structure on the outside, such as a gazebo, remember to allow access for service and insulating cover removal.

### Is there any privacy considerations?

\*To avoid nuisance circuit breaker tripping, it is best to use an outlet on a circuit which does not supply power to any other major running appliance. This can be checked by turning off the circuit breaker that supplies the intended outlet and verifying that no other electrical devices no longer work, such as a refrigerator, dishwasher, washing machine, coffee maker, hair dryer, etc.

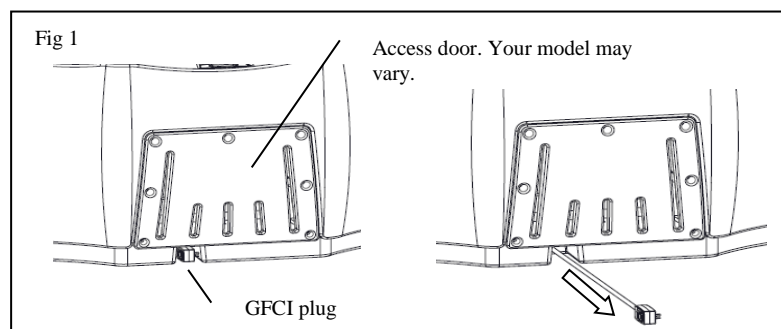

## Spa Cover Installation

### WARNING! AVOID DROWNING RISK

- Failure to follow instructions may result in injury or drowning.
- Non-secured covers are a hazard.
- Keep children away. People or objects cannot be seen under the cover.
- Because of entrapment possibility, remove cover completely before entry of bathers.

When properly installed, the cover supplied with your spa meets the Manual Safety Cover requirements of ASTM F1346-91.

If you are installing your spa near a wall or with any type of structure on the outside, such as a gazebo, remember to allow access for cover removal.

To deter entrapment by somebody slipping under the cover, assure that all latches supplied with the cover are securely screwed to the cabinet, straps are inserted into the latches, the latches are locked and the key is kept in a secure location.

Keep the spa covered when not in use to deter entry by unauthorized persons, reduce the loss of heat, and keep out rain and to keep foreign materials from settling in the water.

### Follow these steps to properly install the cover.

1. Place the spa cover on top of the spa. Assure the cover flaps and straps are not under the cover. Assure the cover is properly seated in its final position.
2. Each strap is supplied with a cabinet latch snapped in place. Leave the cabinet latches at the end of the straps, but remove the bag containing the screws and while lightly pulling downward on a strap, mark the center bottom of the latch (fig 1). A piece of tape may be a good method to do this. Mark each remaining strap in the same way.
3. Remove the strap by pinching the two barbs of the strap as indicated (fig 2).
4. Hold the cabinet latch on the mark and using a Phillips screwdriver, drive three screws through the holes in the cabinet latch and into the outside of the spa (fig 3).
5. While the spa is not in use place the cover on top of the spa and snap all straps into the cabinet latches. To further protect against entry, lock each latch by quarter turning the key clockwise (fig 4). Store the key in a secure place.

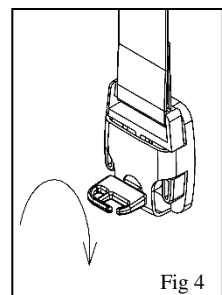
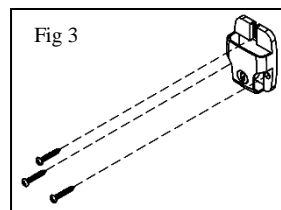
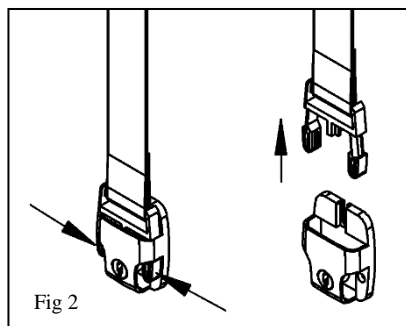
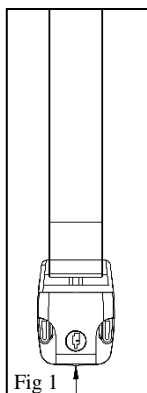

## Filling Your Spa

**Warning!** Your spa is constructed of a very resilient and flexible polymeric material. It is designed to flex as much as 2 inches (5cm) without damage. However, overfilling the spa and/or installing on a non-level surface for extended periods of time can permanently distort the original shape of your spa, cause structural damage, effect the sealing of the cover and may void your warranty in this area.

Remove the access door (Fig 1) and assure the drain valve is closed and the cap is secure (fig 2).

Place a garden hose into filter area (Fig 3) and fill the spa with cold (never warm or hot) water 6 to 8 inches (150 to 200 mm) below the top edge of the spa (Fig 2.1). Do not overfill, as the spa's water level will rise as each person enters the spa. Always keep the spa water level above the jet openings.

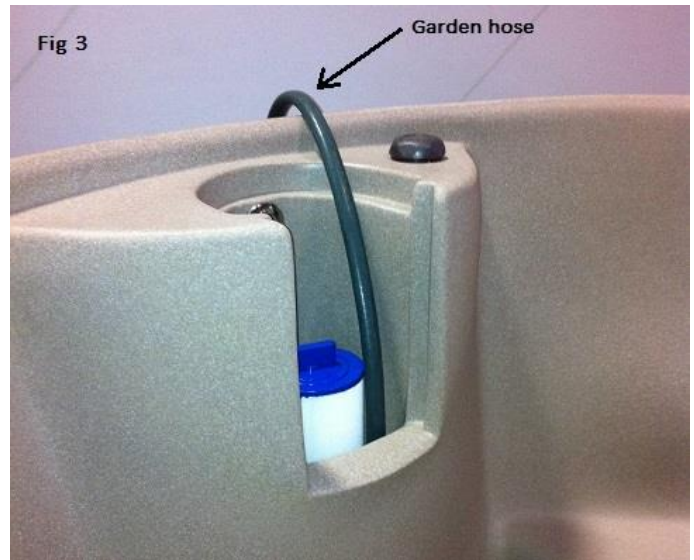
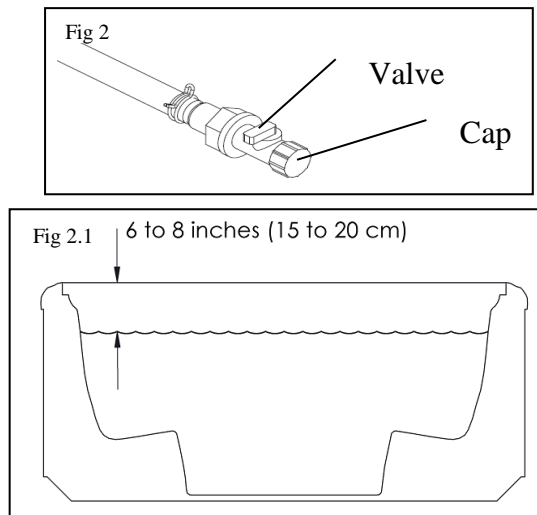

## Draining the spa

Draining your spa on a regular basis rids the spa of dissolved solids and protects your spa equipment from the effects of residual calcium hardness and total alkalinity problems. Depending upon usage, it may be as often as every three months.

To drain the spa follow these steps:

1. Turn power off to the spa.
2. Remove the access door (Fig 1) and locate the drain valve (Fig 2).
3. Assure that the drain valve is in the off position (as shown in figure 2). Remove the cap (Fig 2) and attach a standard garden hose to the drain valve (Fig 4).

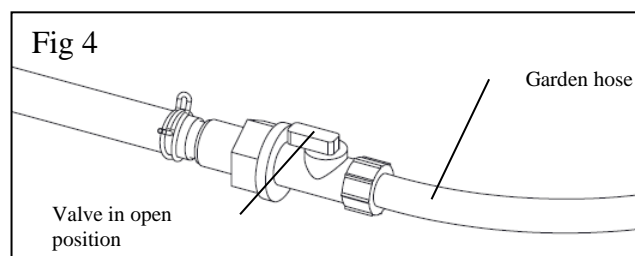

4. Route the garden hose to a sewer drain capable of safely assimilating 300 plus gallons of water which may contain both unsanitary contaminants and chemical residue. Open the drain valve (as shown in Fig 4). The spa drains slowly.
5. The spa can only drain to the lowest jet. It may be necessary to manually remove the remaining water.
6. Before refilling your spa, assure that the drain valve is in the off position and the cap is secured (Fig 2).



## System Operation

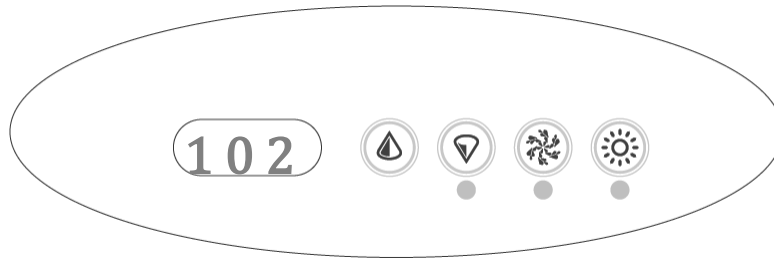



### Initial Start-Up



When your Spa is first activated, it will perform a self diagnostics test showing a series of numbers followed by Pr, then by - along with the low speed pump for approximately 7 minutes total. Also the internal clock that keeps track of the filtration cycles every 12 hours will start at that point. The system is preset to heat up to 100° F (37° C) and it is also preset to run on low speed for two hours (F2). If after the first 7 minutes water is not flowing from the jets you may need to purge the pump. Please see page 21.

### Temperature Adjustment



70° F-104° F (21°C-40° C)

When either of the temperature pads  or  are pressed once, the LCD will display the temperature which has been set. Each time either one of this pads are pressed again, the temperature will change by 1°, After 5 seconds, the LCD will automatically display the current spa temperature.

### Jets

Press the  pad to power the pump. The pump will sequence with each press of the  pad as follows: low flow – high flow – off. If left running, the high flow pump will automatically turn off after 30 minutes (low flow in two hours). These time out durations can be adjusted. See page 14 for details.

### Adjustable LED Light

To turn the light on, press the  button. Press again to turn it off. To adjust the color modes, press the  button immediately after turning it off. The light will come back on in a new color mode. Each time you repeat this procedure, the light will cycle to a new color mode, as shown below. If left on, the light will automatically turn off after four hours.

1. Color wheel. The light will slowly blend cycle through the colors.
2. Aqua white.
3. Light blue.
4. Violet.
5. Dark blue.
6. Light green.
7. Dark green.
8. Red.
9. Step sequence through the colors.
10. Strobe.
11. Back to #1.

(For additional features and display messages, see next pages.)

## Spa Water Maintenance

This function enables you to program the amount of water filtration time.

Press  or  and  to enter the programming mode.

Once in the programming mode press  or  to select the filtration time.

**F2** In this mode the water will be filtered for 2 hours every 12 hours.

**F4** In this mode the water will be filtered for 4 hours every 12 hours.

**F6** In this mode the water will be filtered for 6 hours every 12 hours.

**F8** In this mode the water will be filtered for 8 hours every 12 hours.

**FC** In this mode the water will be filtered continuously.



To exit press  .

## Standby Mode (SY)

This function allows you to disable the equipment when the filter requires service without disturbing programmed filtration time.

Press  repeatedly (or hold it down) until it gets to 70° F (21° C) then press it one more time (within a couple of seconds) to enter the stand by mode. All spa functions are disabled except for freeze control. To exit from standby press any button and re-enter desire set temperature.

## Spa heating modes

The Heating Mode offers the ability to control your heater in special circumstances. Your spa is preset at the factory to Standard Mode. However, the Standard Heating Mode can be changed to Economy or Sleep by pressing the  or  then  button. With each press of the buttons, the display will cycle through the three different modes described below.

**Standard Mode (ST):** Your spa is preset to this mode. This mode operates the heater whenever needed to maintain the programmed spa water temperature. (See Temperature Adjustment page 9).

**Economy Mode (EC):** This mode operates the heater only during programmed Filtering Cycles (See Spa Water Maintenance above). This mode is ideal for areas that charge a premium for electricity during peak hours. This mode will maintain the thermostat setting. If it does not reach the thermostat setting, you may have to allow for more heating time by increasing the Filtration Cycles.

**Sleep Mode (SL):** This mode works in the same manner as the Economy Mode except the thermostat setting is automatically lowered by 20 degrees. This mode is best suited for extended leaves from home when it is not important to maintain constant water temperature, such as vacations or business trips.

## Summer Set Temperature

In hot weather, it is possible for water temperature to exceed the temperature setting. This is especially common when your temperature setting is lower than air temperature. If the water temperature exceeds the temperature setting more than 3°F (1°C), the pump will stop running automatically except during filter cycles. Normal operation will resume when the water temperature cools to below the setting, or the setting is increased above the water temperature.

## Display Messages

MESSAGE	MEANING	ACTION REQUIRED
	No message on display. Power has been cut off to the spa.	The control panel will be disabled until power returns. Spa settings will be preserved until next power up.
--	Temperature unknown.	After the pump has been running for one minutes, the temperature will be displayed.
H H	Overheat -The spa has shut down. One of the sensors has detected 47°C (118°F) at the heater.	DO NOT ENTER THE WATER. Remove the spa cover and allow water to cool. Once the heater has cooled, reset by pushing any button. If spa does not reset, shut off the power to the spa and call your dealer or service organization.
O H	Overheat" -The spa has shut down. One of the sensors has detected that the spa water is 43°C (110°F).	DO NOT ENTER THE WATER. Remove the spa cover and allow water to cool. At 41°C (107°F), the spa should automatically reset. If spa does not reset, shut off the power to the spa and call your dealer or service organization
1 C	Ice -Potential freeze condition detected.	No action required. The pump will automatically activate regardless of spa status.
S A	Spa is shut down. The sensor that is plugged into the "A" jack is not working.	If the problem persists, contact your dealer or service organization. (May appear temporarily in an overheat situation and disappear when the heater cools.)
S b	Spa is shut down. The sensor that is plugged into the "B" jack is not working.	If the problem persists, contact your dealer or service organization. (May appear temporarily in an overheat situation and disappear when the heater cools.)
S N	Sensors are out of balance. If alternating with spa temperature, it may just be a temporary condition. If flashing by itself, spa is shut down.	If the problem persists, contact your dealer or service organization.
H L	A significant difference between temperature sensors has been detected. This could indicate a flow problem.	Check water level in spa. Refill if necessary. If the water level is okay, make sure the pumps have been primed. If problem persists, contact your dealer or service organization.
L F	Persistent low flow problems. (Displays on the fifth occurrence of "HL" message within 24 hours.) Heater is shut down, but other spa functions continue to run normally.	Follow action required for "HL" message. Heating capability of the spa will not reset automatically; you may press any button to reset.
D R	Possible inadequate water, poor flow, or air bubbles in the heater. Spa is shut down for 15 minutes.	Water level in spa. Refill if necessary. If water level is okay, make sure the pumps have been primed. Press any button to reset, or this message automatically will reset within 15 minutes. If problem persists, contact your dealer or service organization.
D Y	Water detected in heater. (Displays on third occurrence of "DR" message.) Spa is shut down.	Follow action required for "dr" message. Spa will not automatically reset. Press any button to reset.

## FOR THE ELECTRICIAN, HU2 CONVERSION FROM 120V TO 240V

The conversion of the HU2 equipment package, from a factory installed 120 volt system to a hardwired 120/240volt system, must be completed by a certified licensed electrician. This procedure will convert the heater from 120 volts (1000 watts) to 240 volts (4000 watts). All other electrical components will remain 120 volts, so it will be necessary to include a neutral wire in the new electrical service. It will also be necessary to select how the heater will operate, thereby dictating the size of the new electrical service. If the heater will operate only when the low-speed pump is running, then a 30 amp service will be used and the #10 dip switch will be set to the **low amp** position (page 14). If the heater will operate when both high and low-speed pumps are running, then a 50 amp service is required and the #10 dip switch will be set in the **high amp** position. Regardless of your choice, the following will also have to be done.

1. Remove and discard the 120 volt GFCI power cord.
2. Remove and discard the white wire jumper between J28 and J57 (dotted line shown in above diagram).
3. On J11, install small black jumper block on the two pins.
4. Move #10 dip switch to proper position: low amp for a 30 amp service, or high amp for a 50 amp service.
5. When supplying the new 4 wire service, connect line 2 to the terminal indicated by the dotted line in the above diagram.

### Additional wiring information:

**GFCI PROTECTION:** The new service must be protected with by a GFCI and a disconnect switch. The National Electrical Code requires that spas connected to 240 volts circuits be equipped with a GFCI and disconnect switch. See National Electric Code Articles 680-12 and 680-42. P1 series spas are not equipped with a 240 volt GFCI or a disconnect switch. A GFCI must be installed by a certified licensed electrician.

**OUTDOOR LOAD CENTER:** The addition of an outdoor load center such as a Siemens W0408ML 1125 or equal must be added to the circuit. This type of load center provides both a GFCI and Disconnect Switch in a convenient configuration as required by the National Electric Code. (See next page for suggested wiring configuration)

**ISOLATED, DEDICATED 240 VOLT, 30 OR 50 AMP CIRCUITS ARE REQUIRED** An isolated, dedicated 240 volt, 30 or 50 amp circuit is required to provide the power necessary to properly operate the 240V equipment package.

**PERMANENTLY HARD WIRED:** All 240 volt operations wiring must be permanently hard wired, installed in grounded conduit and installed in compliance with the National Electrical Code and all local codes.

**WIRE SIZING MUST MEET ELECTRICAL CODES:** All installations are different. Wire sizing must meet the National Electrical Code and all local code specifications.

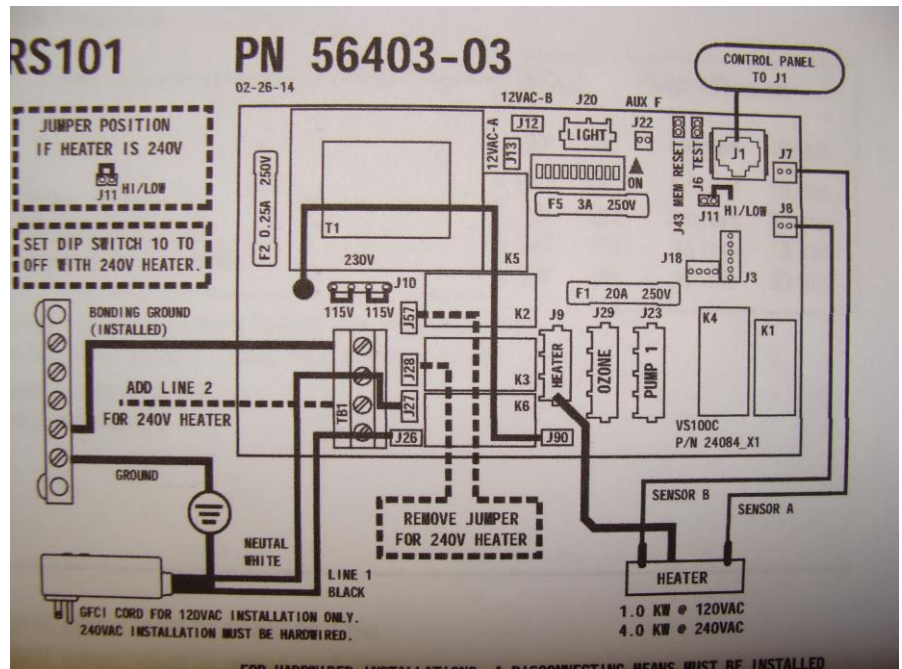

See next pages for more conversion details

FOR THE ELECTRICIAN, CONVERSION FROM 120V TO 240V continued:

ELECTRICAL DATA FOR THE USE OF CERTIFIED LICENSED ELECTRICIAN

**WARNING: Shock Hazard! Under No Circumstances Should This Spa Be Installed By Anyone Other Than A Certified Licensed Electrician!**

## REQUIRED WIRING FOR 240 VOLT INSTALLATION

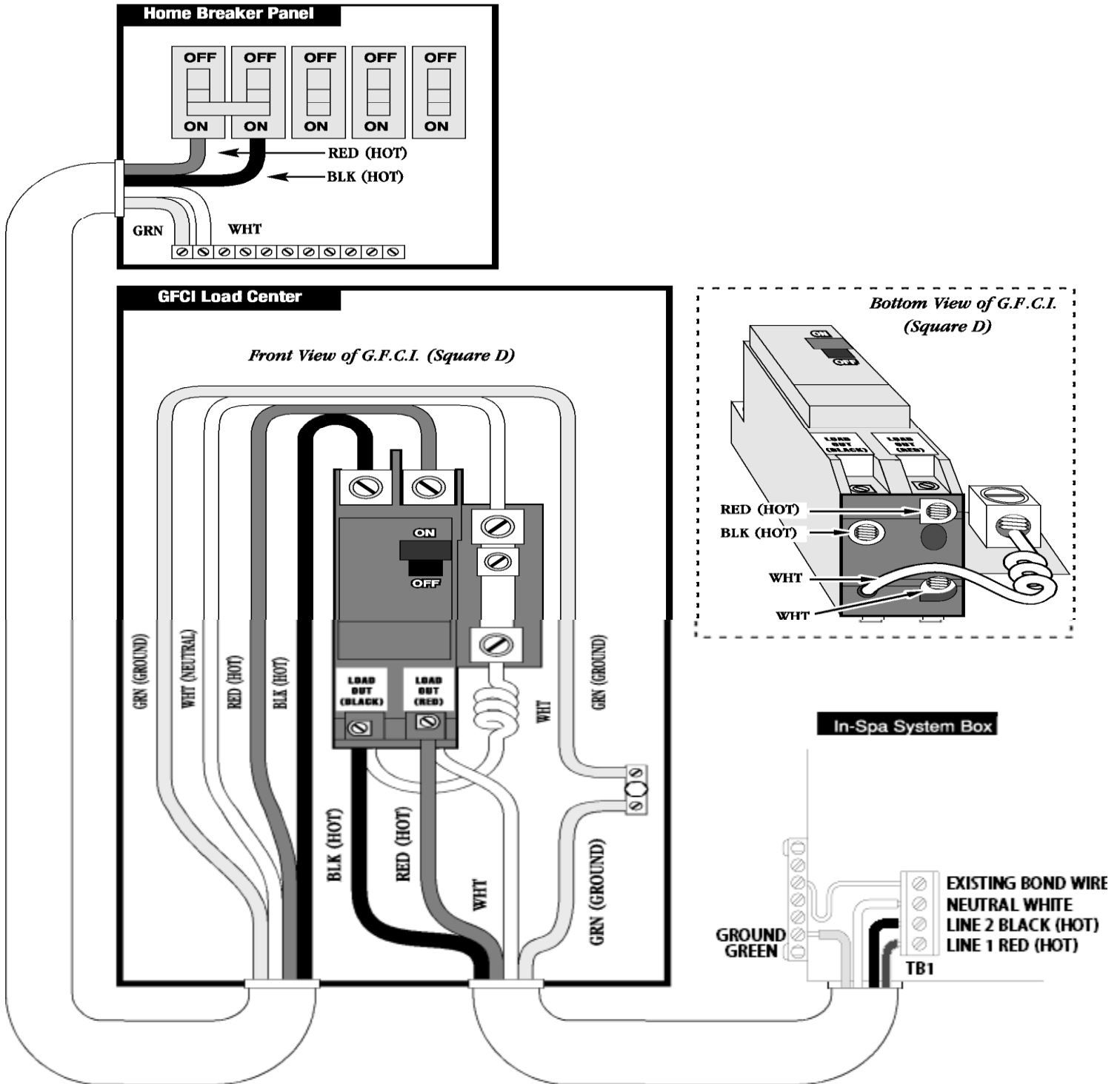

All wiring MUST be in accordance with the National Electrical Code and all local codes

FOR THE ELECTRICIAN, CONVERSION FROM 120V TO 240V continued:

DIP SETTINGS 56403-03 VERSION 03

MAIN POWER TO SYSTEM SHOULD BE TURNED OFF BEFORE ADJUSTING DIP SWITCHES

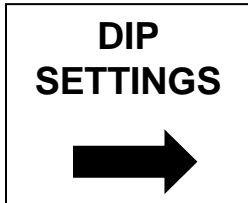

TEST MODE OFF	← 1	TEST MODE ON
N/A	← 2	N/A
DUPLEX PANEL	3 →	MINI PANEL
N/A MUST BE OFF	← 4	N/A MUST BE OFF
SEE PUMP TABLE	5 →	SEE PUMP TABLE
60HZ OPERATION	← 6	50HZ OPERATION
STD, ECON, SLEEP ALLOWED	← 7	STANDARD MODE ONLY
DEGREES FAHRENHEIT	← 8	DEGREES CELSIUS
SEE PUMP TABLE	← 9	SEE PUMP TABLE
HIGH AMP – HEAT W/P1 HI	10 →	LOW AMP – NO HEAT W/P1 HI

PUMP TIMEOUTS TABLE

<u>Switch 5</u>	<u>Switch 9</u>	<u>Low speed</u>	<u>High speed</u>
<u>Off</u>	<u>Off</u>	<u>2 Hours</u>	<u>15 Minutes</u>
<u>On</u>	<u>off</u>	<u>2 Hours</u>	<u>30 Minutes</u>
<u>Off</u>	<u>On</u>	<u>15 Minutes</u>	<u>15 Minutes</u>
<u>on</u>	<u>On</u>	<u>30 Minutes</u>	<u>30 Minutes</u>

### Air Injection Venturi Adjustment

Air injection into the massage jet water flow may be controlled by turning the venturi dials located on either side of the spa.



### Surface Skim Filter

The spa's automatic surface skim filter is designed to remove floating debris and contaminants such as body lotions by drawing water through a specially formulated filter cartridge. It is critical that this element be routinely cleaned.

### Cleaning the Filter Cartridge

To clean the filter cartridge follow these steps:

1. Turn off power to the spa.
2. Remove the end nut by turning it counter clockwise (Fig 5).
3. Pull up filter cartridge (Fig 5).
4. Remove the cartridge and thoroughly rinse with a garden hose until the cartridge is free of dirt and debris.
5. Return the clean cartridge to the filter well and turn the end nut clockwise until snug.

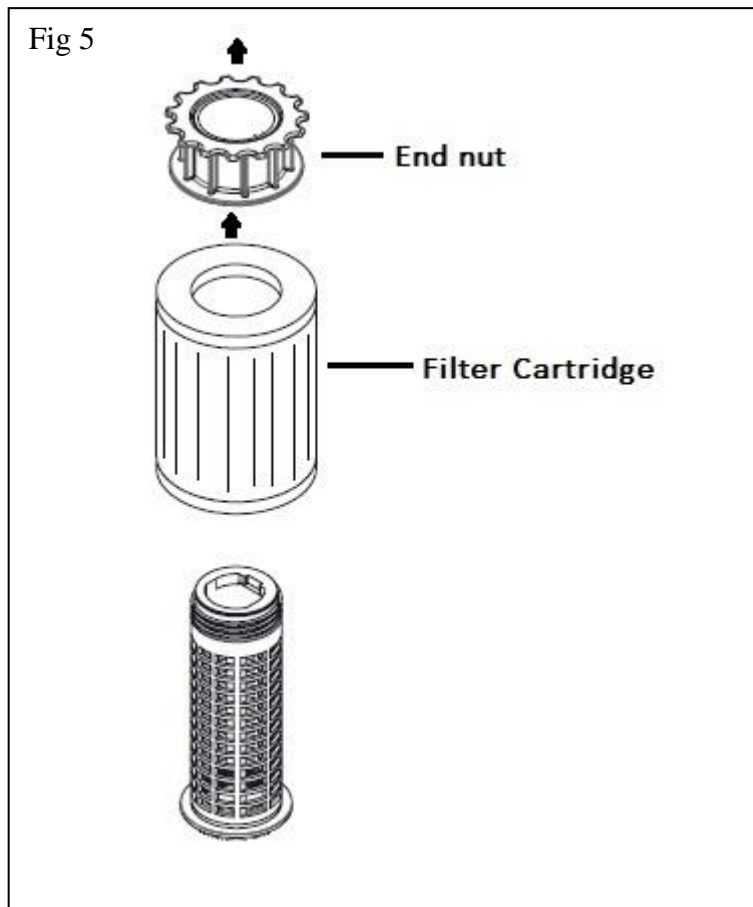

Spa water chemistry (or water balance) affects the safety of your equipment as well as the appearance of your spa water. Water balance has five factors: pH, total alkalinity, calcium hardness, temperature and total dissolved solids. pH is the most critical but total alkalinity and calcium hardness must also be watched closely. Low calcium hardness can lead to corrosion of equipment, while high calcium hardness can lead to scaling, cloudy water and staining. Water temperature should never exceed 40°C (104°F), and total dissolved solids should be kept below 1500 PPM. Algicidal and sanitizing chemicals are either alkaline or acid. Sodium and calcium hypochlorites are alkaline. Chlorine gas and practically all other dry chlorine spa products are acid. On the market are a number of bromine sanitizers. Bromines are usually preferred since they don't emit a strong chlorine odor.

### **SEE YOUR SPA WATER EXPERT FOR ADDITIONAL INFORMATION**

### **Damage due to improper chemistry may void warranty**

1. Check and adjust water conditions. You must maintain proper chemical balance to insure safe sanitary conditions and to prevent your spa from becoming a breeding place for bacteria. This is done by:
  - A. Test daily and maintain pH between 7.2 and 7.8. Adjust if necessary, above 7.8 use pH decrease, if below 7.2 use pH Increase. Improper pH can damage spa finish, equipment, cause eye irritation and chemical loss. Use dosage according to manufacturer's label.
  - B. Test alkalinity and maintain at 80 ppm to 140 ppm. Adjust if necessary, above 140 ppm use pH Decrease, if below 80 ppm use Total Alkalinity Control. Use dosage according to manufacturer's label.
  - C. Test daily and maintain proper sanitizer level. It's recommended to use bromine sanitizer and maintain bromine at 3.0  
5.0 ppm. Typically two or three bathers relaxing in an average spa with 103°F (39°C) temperature will consume all the bromine sanitizer in about twenty minutes. Therefore, prolonged or heavy use may require additional bromine to maintain safe sanitary conditions.
  - D. "Shock" (with a non-chlorine shock) once a week and after each water change. Do not use spa until the bromine residual has dropped to less than 5.0 ppm. NOTE: Improper pH will cause early corrosion to your pump.  
Corrosion is not handled under any warranty.

### **SPA MAINTENANCE SCHEDULE**

#### **DAILY**

Test and maintain pH: Ideal range 7.2 - 7.8b.

Test and maintain bromine: Ideal range 3.0 - 5.0 ppm.

#### **WEEKLY**

Test and maintain alkalinity 80 - 140 ppm. Shock with a non-chlorine shock.

Add Spa Clear.

#### **MAINTENANCE**

Add defoamer as needed.

Inspect filter cartridge every 2 weeks and clean when needed.



It is recommended that the spa be drained regularly depending on its size, location and the frequency of use.

1. Clean filter and cartridge periodically according to manufacturer's instructions.
2. Keep the spa covered when not in use to reduce the loss of heat and to keep out leaves, dirt, and other foreign materials from settling in the water.
3. Since the water capacity of your spa is far less than that of a swimming pool, the chemical reaction caused by the presence of one or more persons in the spa is more rapid and pronounced. For these reasons, it is important to frequently check the bromine level, the pH level and total alkalinity of water then add the prescribed chemicals as necessary to maintain the proper chemical balances.
4. If questions or doubts arise regarding quantities and timing or chemical applications to your spa, contact your spa dealer who can assist you in prescribing the correct program for your spa.
5. Store all chemicals in a cool dry place and in such a manner as to prevent contact by children and pets.
6. When adding chemicals to your spa water, add to the center of the spa with the pump operating. Never add chemicals to unheated water as this will affect chemical action.

## Replacing the LED light.

1. Turn off power to the spa.
2. Using a Philips screwdriver, remove the access vent located on the outside of the spa, directly behind the filter (Fig 7.1).
3. Reach in and turn the white holder counter clockwise and gently pull it, with the attached wires, out the access hole (Fig 7.2).
4. Pull the LED light out of the light socket (Fig 7.3).
5. Install a new LED light, attach the white reflector turning clockwise and reattach the access vent with the screws.



### DO NOT ALLOW THE SPA TO FREEZE

If the spa is to be stored or transported in temperatures of 32°F (0°C) or lower, it is critical that the unit be fully winterized.

To winterize the spa follow these steps:

- 1 The spa itself must be completely drained of water. See page 8 for draining instructions.
- 2 The drain valve must be in the open position and the cap removed.
- 3 Drain the pump. Remove the pump wet end drain plug (Fig 6.1). Leave this plug out until it is time to refill the spa.

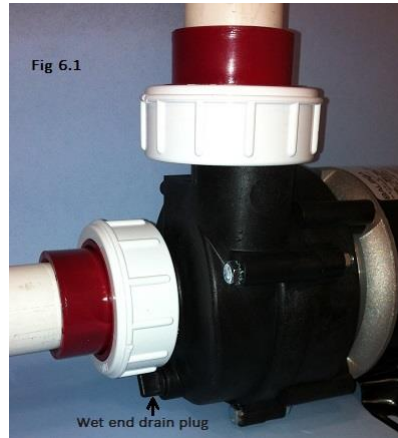

- 4 The filter cartridge must be removed, dried and stored. See page 15 for instructions for removing the filter cartridge.
- 5 The spa must be inverted (turned upside down) for at least five minutes to facilitate draining of the internal plumbing.

### CLEANING YOUR SPA

Do not use cleaners or compounds containing harsh abrasives. Also, avoid using heavy-duty rubbing or buffing compounds. Use a soft liquid cleaner.

### CARE OF VINYL HARD COVER

Vinyl coated fabrics are perhaps the most maintenance-free fabrics ever produced and certainly will provide exceptional service life if given the proper care. Almost all vinyl manufacturers now provide information concerning the necessary cleaning procedures for their products. In reality, all care maintenance instructions are the same for all coated fabrics regardless of their manufacturing origin.

Products are now on the market which are manufactured to enhance the beauty and service life of all vinyl. However, by using methods described below with minimal care and attention, you should enjoy years of satisfaction and pride with any vinyl coated fabric.

### EVERYDAY SOIL

A gentle mixture of any mild soap and warm water will generally dissipate most common soil from the surface. Using a soft cloth, wash the area to be cleaned and rinse. If stubborn dirt remains, as a stain embedded in the grain of the vinyl, use a soft brush, and if necessary, a touch of cleaning powder. In both situations, rinse and dry with a soft cloth.

## Most Frequently Asked Questions

1. **Why does my spa not shut off?** Your spa is designed to run from the time you plug it in to run until it reaches your desired temperature. Once desired temperature is reached then you can control the on/off with the buttons on the top control. **For example: On the initial startup the spa will run for approximately 18 hours to reach 38°C (100°F). At that point the spa will shut off, and then the spa will maintain your desired temperature settings. Keep in mind that anytime power is disrupted from the spa, the spa will reset itself and run until it reaches the spa's default settings.**
  
2. **Why does my spa turn on late at night?** The spa is designed to filtrate every 12 hours. The clock starts the second you plug it in. Recommend unplugging and plugging back in between 7 and 8. This means the spa will come on every 12 hours at the designated time and filter the amount of time you have it set for.
  
3. **Why is my spa hotter than it is set for?** If your spa is set for 101°F (38°C) but it reads 103°F (39°C) most likely your filter cycle is set too high. Adjust your filter cycle down to the next lower setting or **F2**. Remember, when the spa is running to filtrate it is also heating.
  
4. **Why is my spa not heating?** All spas heat at approximately 1.5° F (1°C) per hour. If your water temperature is 70°F (21°C) when you first fill your spa it will take approx. 20 hours to reach 100°F (38°C). **Remember, it is imperative to keep your safety cover on and the air control valves turned off while heating.**
  
5. **How do I change the light bulb?** See page 18.
  
6. **How many gallons does my spa hold?**

Model <small>First three characters on rating plate</small>	AR-200	AR-300	AR-400	AR-500	AR-600
	ECL	TRI	X4H	X5H	EZB
Gallons	180	160	190	215	240
Liters	681	598	723	806	916

7. **I see water on the floor. What does this mean?** The cover can accumulate condensation between the seams and run down the sides of the spa. You can verify that water is coming from the cover by squeezing the seam, or by repositioning the cover so that the seam is on a different side. This only occurs when the temperature and humidity are at certain levels.
  
8. **What do I do if I cannot fix a problem?**  
Contact the dealer from whom you purchased the spa.

## PURGING THE PUMP

Sometimes after a water change (draining and refilling the spa), or initial start-up of the spa, there is no water flowing from the jets. You may hear the pump operating or even see the shaft of the pump motor turning, but have no water flowing from the jets. In addition to no flow out of the jets, you may even see an error message dr, dY, HH, OH, HL, or LF. All of these error messages can be caused by a lack of water flow. When this happens there is probably an air-lock in the pump. This air-lock must be purged from the plumbing for the pump to operate normally.

To purge the pump, please follow these steps:

1. Assure the spa is filled 6 to 8 inches (15 to 20 cm) below the top of the spa.
2. Remove the access panel to expose the water pump.

The pipes entering and leaving the pump are connected with large plastic unions. To purge the air from the pump, one of these unions will be slightly loosened.

3. Place a towel under the union to be loosened.
4. Using large pliers, slightly turn the union nut counterclockwise (Fig 8). This will produce a faint hissing sound of the trapped air escaping the pump. This will be followed by a small squirt of water which signals it is time to close the union by turning it back (clockwise). Do not over tighten the union. It is designed to be hand tight.

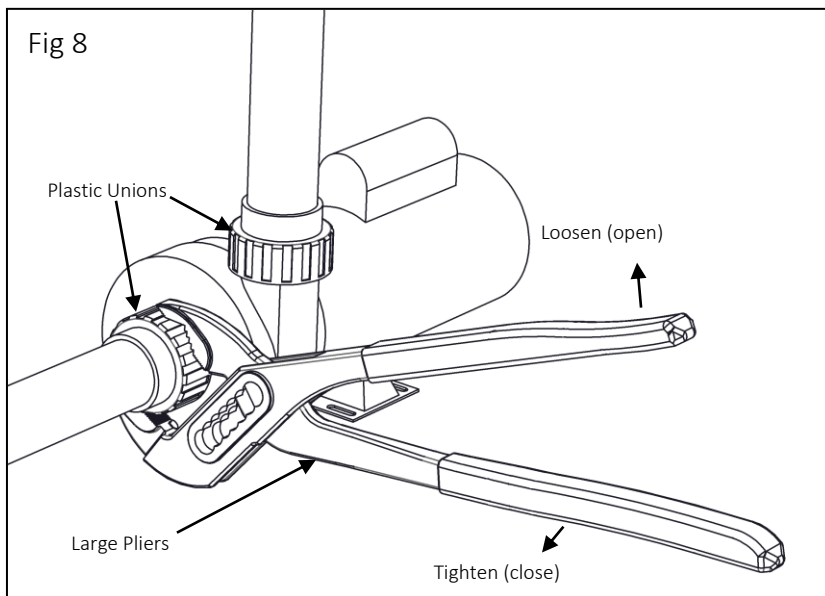

## Troubleshooting Guide

SITUATION	PROBABLE CAUSE	ACTION
NO HEAT OR HEAT TOO LOW	Operating while spa cover is open.	Ensure that spa cover is properly closed.
	Dirty filter	Remove filter cartridge and clean.
JETS WON'T COME ON	No power to spa control.	Check the GFCI plug, circuit breaker and/or disconnect switch.
NO CONTROL DISPLAY OR FUNCTIONS	No power to spa control.	Check the GFCI plug, circuit breaker and/or disconnect switch.
LOW WATER FLOW	Dirty filter.	Remove filter cartridge and clean. Pg. 15
	Low water level.	Make sure water level in spa is correct.
NO AIR BUBBLES IN JET	Air control valve in the closed position.	Open venturi dials. Pg. 15.
SPA IS LEAKING	Spa drain valve and cap partially open.	Ensure that drain valve and cap are fully closed. Pg. 8
NO SPA LIGHT	Burned out bulb.	Replace bulb. Pg. 18
SLOW WATER DRAIN	Drain valve not fully opened.	Ensure that valve is fully open. Pg. 8
	Dirty filter.	Remove filter cartridge and clean. Pg15
	Kinked garden hose	Ensure drain hose is not kinked and is in a downhill direction.
NO WATER FLOW FROM JETS	Air lock in pump	Purge the pump. Pg. 21

**Venturi dials**

Mounted on the lip of the spa or at the equipment shroud, to induce air to the jets.

**BYPASS CHECK VALVE**

Prevents water flow stoppage due to dirty filter.

**CONTROL BOX**

Basically the brain of the spa. Power is distributed to all functions of the spa, pumps, lights, heat, etc.

**DRAIN VALVE**

Used in the draining of the spa, looks like an outdoor faucet and fits a standard garden hose.

**FILTER**

The filter cleans the spa and removes particles and debris and protects the equipment from foreign substances.

**FOOTWELL**

The bottom of a spa where you place your feet.

**GFCI PLUG**

The electronic switch installed at the end of the power cord to connect to an electrical wall outlet.

**HEATER** The thermostatically controlled heater raises the temperature of the water to the desired degree. This is located under the control box in the equipment area.

**JETS**

The fittings on your spa that direct the flow of water for massaging action.

**pH**

Stands for "Potential for Hydrogen" This is the term used to describe the acid (low pH) or alkalinity (high pH) condition of the water. The ideal pH for spa water is 7.5.

**SKIMMER** The skimmer removes surface debris to the filter. The water level in the spa should be kept at the proper range for optimum skimmer operation.

**TOP CONTROL PANEL**

Mounted on the lip of the spa. The digital panel that controls the spas functions.